

Φ50 DC Poly-V Box Conveyor Motor Drive Roller New High-Efficiency Drum Motor For Automatic Transmission Systems

Our Product Introduction

for more products please visit us on drum-roller.com

Basic Information

- Place of Origin: China Jiangsu
- Brand Name: Winroller
- Certification: CE, ROHS2.0, EMC, ISO9001
- Model Number: Winroller Φ50 DC Poly-V Box Conveyor Motor Drive Roller
- Minimum Order Quantity: 1 stick
- Price: Contact Us
- Packaging Details: Wooden case
- Delivery Time: 7-15 word days
- Payment Terms: TT, L/C
- Supply Ability: 1000000/year



Product Specification

- Product Name: Φ50 DC Poly-V Box Conveyor Motor Drive Roller
- Diameter: 50mm
- Voltage: 24V, 48V
- Power: 40W, 50W, 80W, 100w
- Linear Velocity: 0.9-120m/min
- Maximum Load: 45Kg
- Protection Class: IP66/67
- Cylinder Material: S201, S304, Carbon Steel Galvanised
- Highlight: **Automatic Transmission Systems Box Conveyor Roller**, **50mm Box Conveyor Roller**, **50mm Industrial conveyor rollers**



More Images



Product Description

Φ50 DC Poly-V Box Conveyor Motor Drive Roller New High-Efficiency Drum Motor For Automatic Transmission Systems

Features Overview of Φ50 DC Poly-V Box Conveyor Motor Drive Roller New High-Efficiency Drum Motor

Φ50 DC Poly-V Motor Drive Roller For Automatic Transmission Systems, such as unit handling conveyor systems, linear conveyor, small belt conveyor and zero pressure accumulation conveyor.

Function of Φ50 DC Poly-V Box Conveyor Motor Drive Roller New High-Efficiency Drum Motor

Φ50 DC Poly-V Motor Drive Roller is a high performance, high torque, high energy saving, low noise motorized roller, it passed the CE certification, ROHS2.0, EMC certification.

The products are widely used in the drive of unit handling conveyor systems, automatic transmission systems in various industries, transporting cardboard boxes, material boxes, pressure plates or tires at normal ambient temperatures.

At the same time, it is suitable for linear conveyor, small belt conveyor, especially zero pressure accumulation conveyor. It can also be used in shuttle systems to dock conveyor sections or load shifters to other "conveyor system branches".

The diameter is 50 MM, the protection grade is IP54, and the working ambient temperature is -30 °C ~ 60°C.

Application of Φ50 DC Poly-V Box Conveyor Motor Drive Roller New High-Efficiency Drum Motor

Unit Handling Conveyor Systems: Drives conveyors for transporting items like cardboard boxes, material boxes, pressure plates, and tires efficiently.

Automatic Transmission Systems: Utilized in automated systems across various industries for reliable material movement.

Linear Conveyors: Suitable for linear conveyor setups, ensuring smooth and consistent material transport.

Small Belt Conveyors: Ideal for small belt conveyors, including those with zero-pressure accumulation for gentle handling.

Shuttle Systems: Facilitates docking of conveyor sections or integration of load shifters into different conveyor system branches.

Technical Parameters of Φ50 DC Poly-V Box Conveyor Motor Drive Roller New High-Efficiency Drum Motor

Φ50 DC Poly-V Box Conveyor Motor Drive Roller

Application	Φ50 DC Poly-V Box Conveyor Motor Drive Roller For unit handling conveyor systems, automatic transmission systems, linear conveyor, small belt conveyor	Voltage	24V, 48V
Power	40W, 50W, 80W, 100W	Diameter	50mm
Linear Velocity	0.9-120m/min	Cylinder Material	S201, S304, Carbon Steel Galvanised
Maximum Load	45Kg	Protection Class	IP66/67

MODULAR CORE

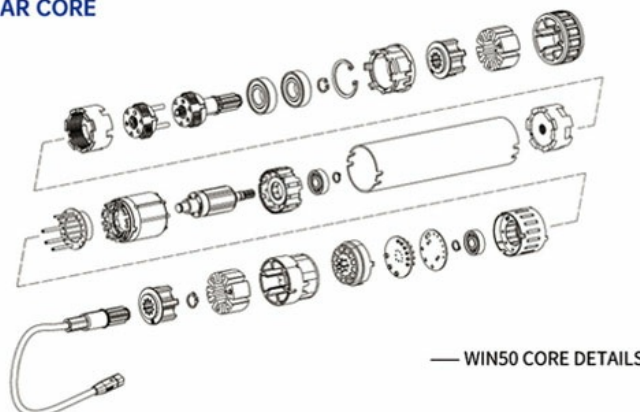

BASIC TECHNICAL PARAMETERS

Voltage	DC24V				DC48V			
	Standard		Enhanced		Standard		Enhanced	
Motor type	S1	S2	S1	S2	S1	S2	S1	S2
Working system	S1	S2	S1	S2	S1	S2	S1	S2
Rated power	40W	50W	80W	100W	40W	50W	80W	100W
Rated current	3A	3.5A	6A	6.8A	1.5A	1.8A	3.2A	4.0A
Starting current	6A	7.0A	11.6A	13.6A	3.0A	3.6A	6.6A	8.0A
Unload running noise	(≤ 55dB)							
Standard cable length	1000mm							
Tube length	300-1500mm							
Working ambient temperature	-30°C ~60°C							
Motor shaft	d12mm							
Anti-Static	yes							
Shell I thickness	1.5mm							
Shell material	X:galvanized steel S3:stainless304							
Shell outside coat	P:PU coated JT:sleeve JZ:rubber JP:PVC JG:silicone							

Note: Switch S1/S2 working system through the controller dip switch function.

WIN50-MOTORIZED ROLLER CHARACTERISTIC TABLE

Nominal speed	Speed adjustable range 8.7%-100%	Standard								Enhanced							
		S1 working system(40W)				S2 working system(50W)				S1 working system(80W)				S2 working system (100W)			
		Torque N.m		Traction N		Torque N.m		Traction N		Torque N.m		Traction N		Torque N.m		Traction N	
		rated	start	rated	start	rated	start	rated	start	rated	start	rated	start	rated	start	rated	start
10	0.87-10	5.5	30.3	220	1210	6.7	33.5	268	1340	9.5	52.5	380	2090	10.6	53	424	2120
14	1.22-14	3.98	21.9	159.2	875.6	4.8	24	192	960	6.8	37.4	272	1496	7.68	38.4	307.2	1536
22	1.91-22	2.8	15.4	112	616	3.37	16.85	134.8	647	4.7	25.8	188	1034	5.36	26.8	214.4	1072
26	2.26-26	2.4	13.2	96	528	2.9	14.5	116	580	4.1	22.6	164	902	4.6	23	184	920
36	3.13-36	1.7	9.4	68	374	2.1	10.5	84	420	2.9	16	116	638	3.3	16.5	132	660
51	4.43-51	1.20	6.6	48	264	1.44	7.2	57.6	288	2.0	11	80	440	2.3	11.5	92	460
60	5.22-60	1.02	5.6	40.8	224.4	1.24	6.2	49.6	248	1.75	9.6	70	385	1.97	9.85	78.8	394
83	7.22-83	0.74	4.1	29.6	162.8	0.9	4.5	36	180	1.3	7.2	52	286	1.42	7.1	56.8	284
120	10.44-120	0.51	2.8	20.4	112.2	0.62	3.1	24.8	124	0.88	4.8	35.2	193.6	0.98	4.9	39.2	196

NOTE: 3-STAGES OF GEAR REDUCTION 2-STAGES OF GEAR REDUCTION

S1 working system--Suitable for continuous material transfer, such as belt conveyor.

S2 working system--Suitable for intermittent material transfer, such as box transfer.

※ 1. 1N=0.1kgf, 1N·m=0.1kgf·m;

※ 2. The value of the characteristic table is for reference only;

※ 3. At constant speed closed loop control, no load or rated load, the speed is consistent;

※ 4. The speed adjustable range is 8.7%-100% of the rated speed;

※ 5. Other speeds can be customized:For faster speeds, please refer to DGDD direct drive motorized roller catalog;

※ 6. Sprocket drive mode conform this table.; Poly-V belt drive mode single modular load 200KG Max.

O belt mode single modular load 35kg Max.

reminder:

The switch power supply of a single motorized roller should be selected 1.5 times according to the motorized roller power.

APPLICATION SCENARIOS

The motorized roller is mainly used for rolling transmission, such as: (straight line conveyor, transverse conveyor, accumulation conveyor, sorting conveyor and turning conveyor). There are also more and more movement applications, such as AGV or AMR load equipment)

-small loader -material box -package -pallet -bearer equipemnt



[SELECTION SAMPLE]

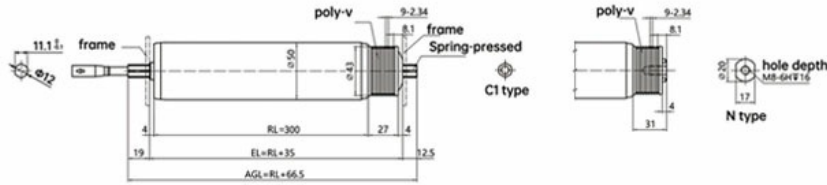

① WIN50 - ② 40W - ③ S - ④ 24V - ⑤ 10M - ⑥ 300L - ⑦ X - ⑧ Q - ⑨ C1 - ⑩ C

Roller type Motor power Power voltage Shell length Drive mode End shaft

Roller diameter Controller type Linear speed Shell material Cable outlet shaft end

② Motor power

40W, 50W (Standard) ;
80W, 100W (Enhanced)

③ Controller type

S100, K100, HB100

④ Power voltage

DC24V, DC48V

⑤ Linear speed

10, 14, 22, 26, 36, 51, 60, 83, 120

⑥ Shell length

Customized according to requirements

⑦ Shell material

X:galvanized	S3:S304
JZ:rubber coated	JT:sleeve
JG:silicone	JP:PVC
P:PU coated	

⑧ Drive mode

Q:poly-v
V:V wheel
T:synchronous wheel
I: Plain straight, No interlocking
L: Dual sprockets
O: Round groove
#: knurl
U: crowned
ZT: taper sleeve



⑨ Cable outlet shaft end

C1: ϕ 12 Hex 11
C2: M12 Hex 11

⑩ End shaft

C: ϕ 12 Hex 11
N: M8 internal thread

APPLICATION SCENARIOS

Comparative item Controller type		VECTOR-S100	VECTOR-K100	HB-100
				
Electrical specification	Rated power	DC24V/48V	DC20V-65V	DC19V-60V
Speed parameter	Speed adjustable range/rpm	600 ~ 6900	1000-6900	600-6900
	Acceleration and deceleration range/s	0.39 ~ 3.9	0.3-4	0.3-4
Electrical connection mode	Number of driving rollers	1	2	4
	PNP	✓ (internal jumper)	✓ (Customer free choice)	✓ (Customer free choice)
	NPN	✓ (internal jumper)	✓ (Customer free choice)	✓ (Customer free choice)
Open-closed loop	Open loop	✓	×	×
	Closed loop	✓	✓ (Default closed loop)	✓ (Default closed loop)
Control mode	External analog	✓ (0-10V)	×	Profinet Ethernet CC-Link Modbus TCP
	IO	✓	✓	
	Multi-speed	3 speed	7speed	
	RS485	✓	✓	
Brake mode	Electronic Brake	✓	×	✓
	Free brake	✓	✓	✓
	Servo brake	✓	✓	✓
Fault output	ERROR-N	×	wrong 0V, true +24V/48V	Computer control self-adaption
	ERROR-P	×	wrong +24V/48V, true 0V	
	ERROR	PNP connection, true 13V, wrong 2V NPN connection, true 13V, wrong 2V	×	

BL50 Linkage mode



DRIVE MODE

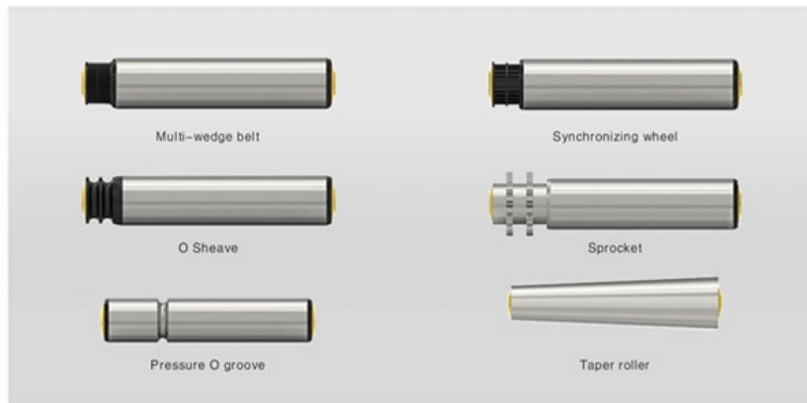

BL50 Surface treatment

The standard model of the electric drum designed by our company is not covered by glue by default. If you need, we can do the glue wrapping treatment. The glue surface has plane, herringbone, diamond pattern, etc; Most specifications can have additional functions; For example, in different environments, the exposed parts such as shaft and barrel can be made of wear-resistant and corrosive materials, stainless steel, etc. Silica gel for food industry is food grade. Waterproof roller can be selected for those with waterproof requirements.



Note : It's just the typical technical data for you reference, The specification such as voltage, speed, torque, shaft can be customized by your needs. Please contact us for more details. Thanks.

Feature Picture of $\Phi 50$ DC Poly-V Box Conveyor Motor Drive Roller New High-Efficiency Drum Motor



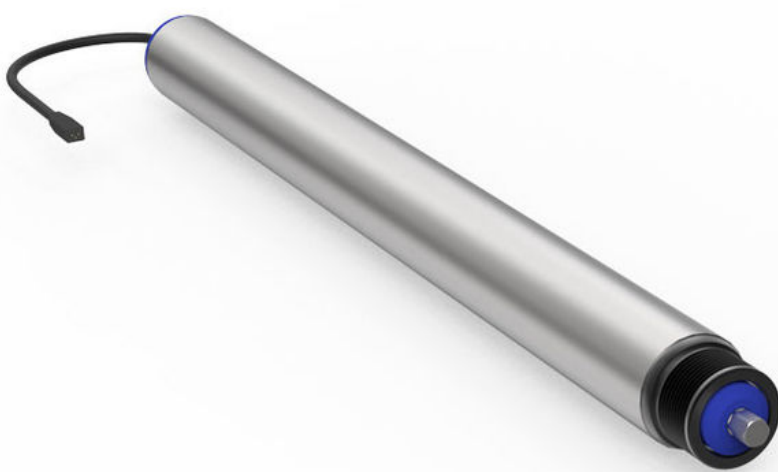



WIN ROLLER JIANG SU Winroller Technology Co., Ltd.

+86 18168399322

winroller.market@gmail.com

drum-roller.com

No. 7, Xiye Road, Huishan District, Wuxi City, Jiangsu Province, China